



GDM-72F

GDM-49F

GDM Freezer Parts Manual

**Includes: GDIM and
GDM (Glass Door
Merchandiser) Models**

TO PLACE AN ORDER OR OBTAIN INFORMATION:

WEB SITE:

www.truemfg.com (Visit our Parts eStore at: <http://estore.truemfg.com>)
Parts Department e-mail address: parts@truemfg.com

SEND INQUIRIES TO:

TRUE MANUFACTURING COMPANY, INC. ATTN: PARTS DEPARTMENT
St. Charles Industrial Center • P.O. Box 970 • O'Fallon, Missouri 63366 • U.S.A

CALL TOLL-FREE:

800-424-TRUE (Direct to Parts Department)
or 800-325-6152 (U.S.A & Canada only)
OR CALL: 636-240-2400

FAX: 636-272-9471



Cabinet End
(For Refurbishing)

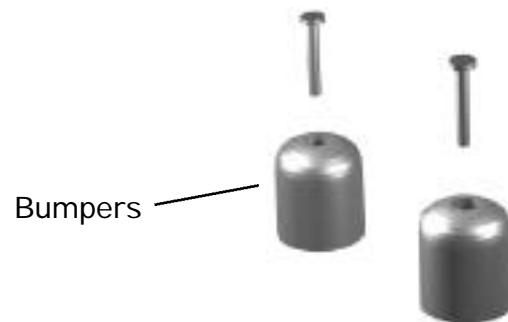

Bumpers

A.

Castors, Legs & Levelers

Castors



Castors
(2 1/2 wheels)



Screw, Leveling
Nylon Foot



Legs



Screw, Leveling



Legs



Legs



Seismec legs



Castors



B.

Compressors

GDM Freezer 1/2 HP or less.

Motor, Condenser Fan

Cord, Power
(Compressor)

Condensing Unit

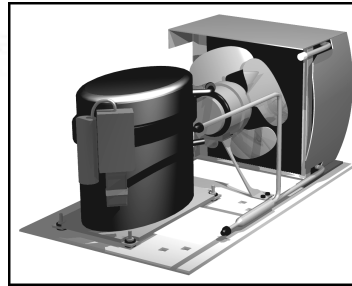

Top Mount Condensing Unit



Bracket,
Fan Motor

Blade, Fan
Motor
Condenser

Accumulator

Cord,
Power

Compressor
Valve-CRO

Outlet, Compressor

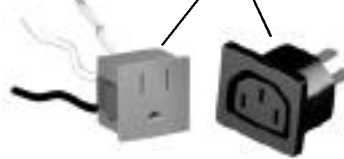

Block, Terminal



— Accumulator &
Shorter Suction Line
for Top Mount Units

Overload

Relay

Capacitor,
start

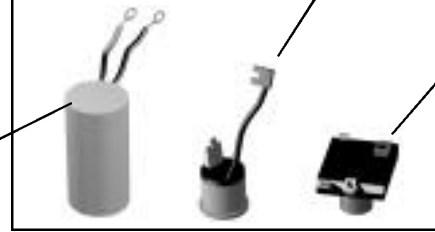

Accumulator &
Suction Line

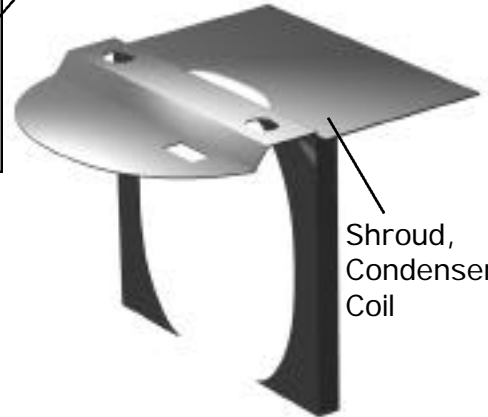

Shroud,
Condenser
Coil

Compressor Pull
out

Compressor

Block

Coil, Condenser

Capillary
Tube

Bolt,
Compressor

Drier,
Compressor

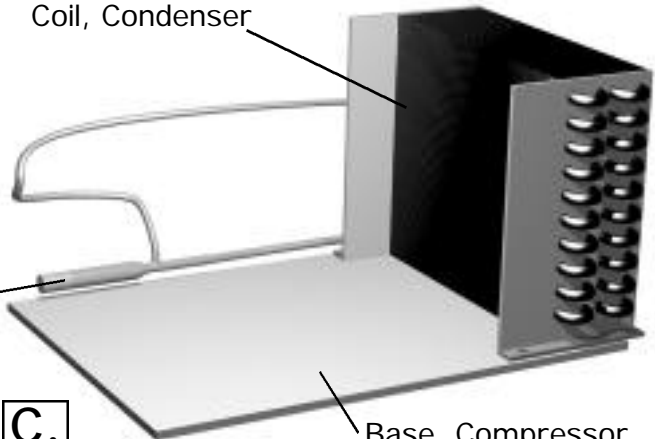
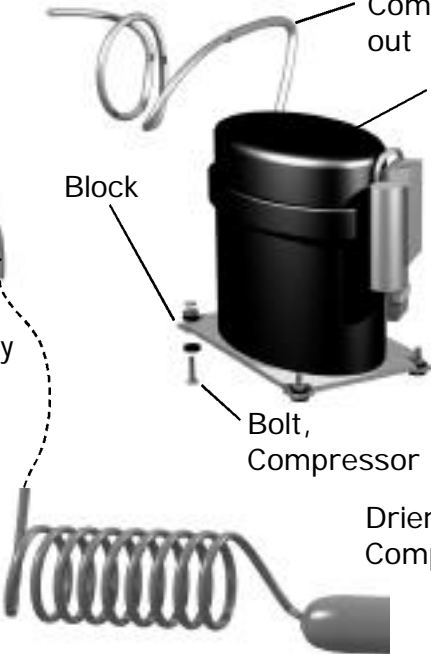

Base, Compressor

C.

Compressors

GDM Freezer 3/4 HP and up.

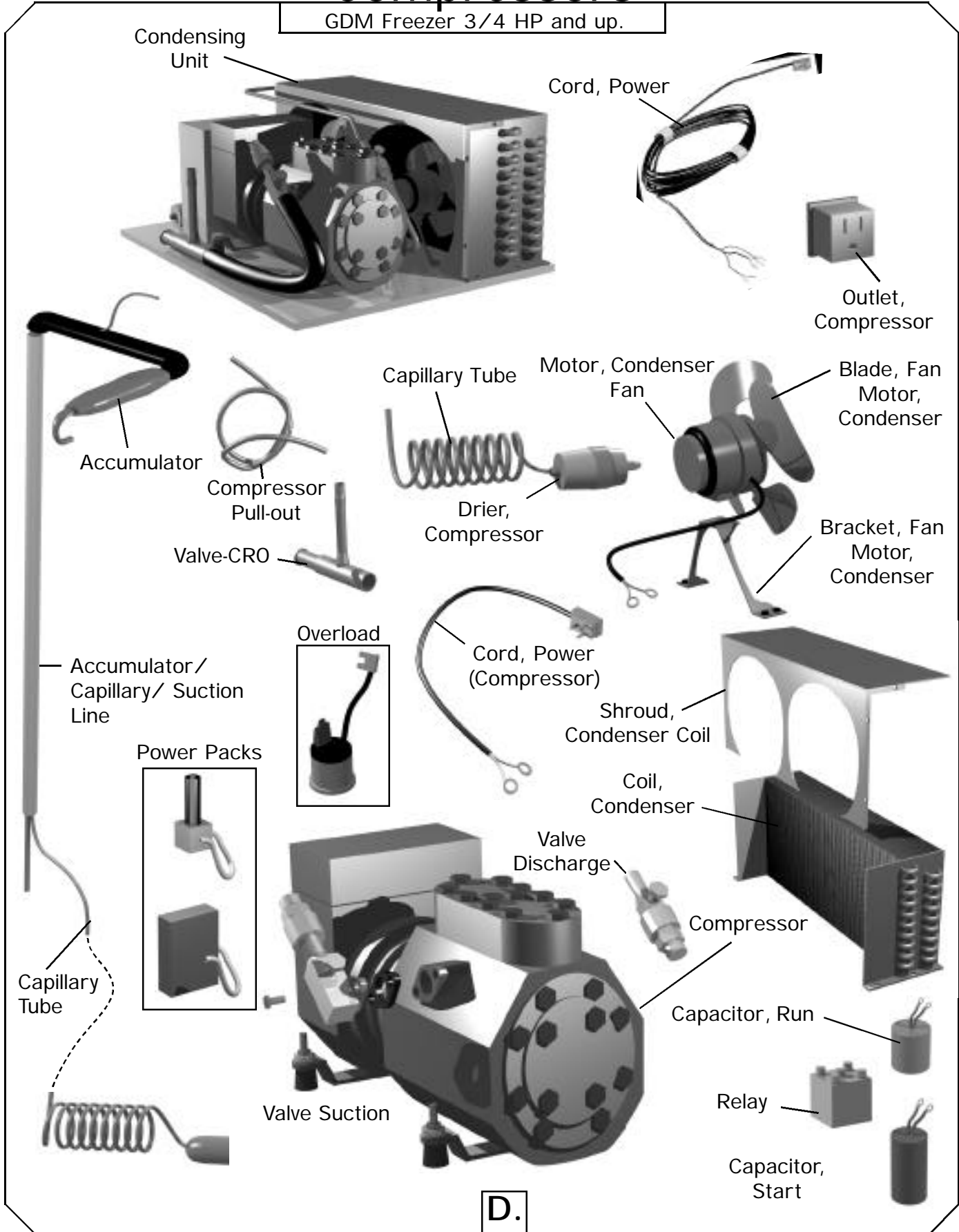

D.

Door Parts

GDM Freezer Swing Door with Integrated Door Light (IDL) VHO Lamp

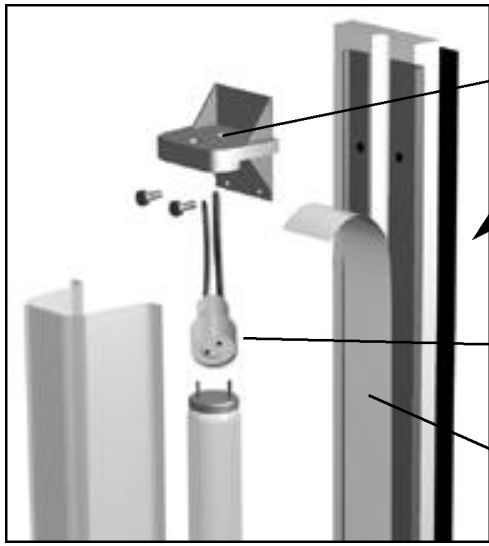

Base, Lampholder

Door

Lampholder Top
#540 with 53 3/4" lead

Tape, Light Filler
Channel Aluminum

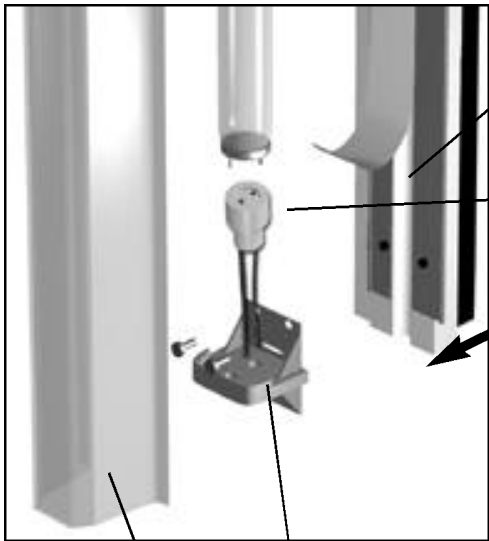

Channel, Light
Filler

Lampholder Bottom
#541 with 5 3/4" lead

Base, Lampholder

Lamp

Tape, Light
Aluminum

Frame,
Door

Lamp Shield

Bushing,
Strain
Relief

Cord, Power,
Door "Y"

Receptacle

Insert, Glass

Cord, Power

Back Plate
Door Gasket

Heater Door Frame
802235

E.

Door Parts

GDM Freezer Swing Door with Integrated Door Light (IDL) 24K

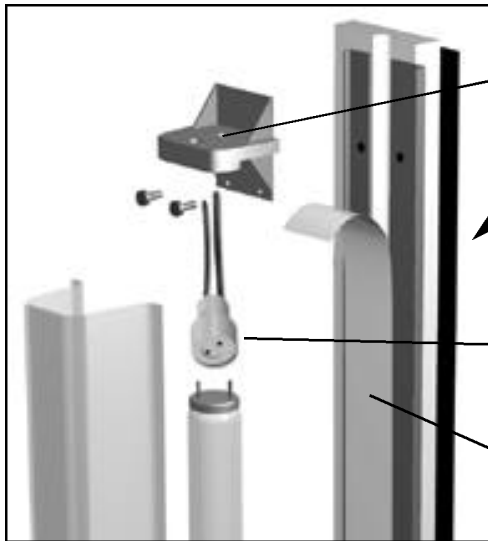

Base, Lampholder

Door

Lampholder Top
#542 with 53 3/4" lead
801230 24K

Tape, Light Filler
Channel Aluminum

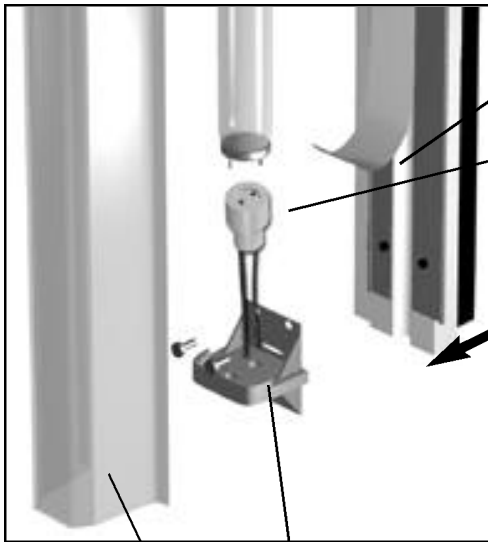

Channel, Light Filler

Lampholder Bottom
#541 with 5 3/4" lead
801254 24K

Base, Lampholder

Lamp Shield

Lamp Shield

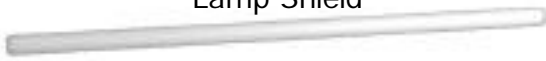

Cord, Power,
Door "Y"



Receptacle

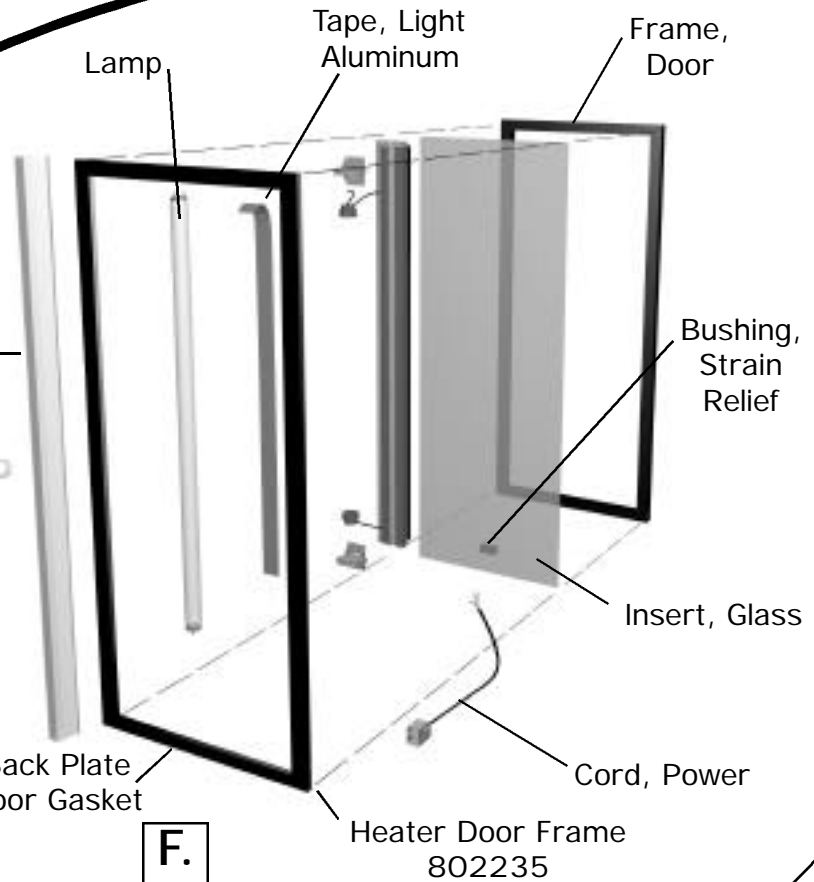

Lamp

Tape, Light
Aluminum

Frame,
Door

Bushing,
Strain
Relief

Insert, Glass

Cord, Power

Back Plate
Door Gasket

Heater Door Frame
802235

F.

Door Parts

GDM Swing Door Non IDL

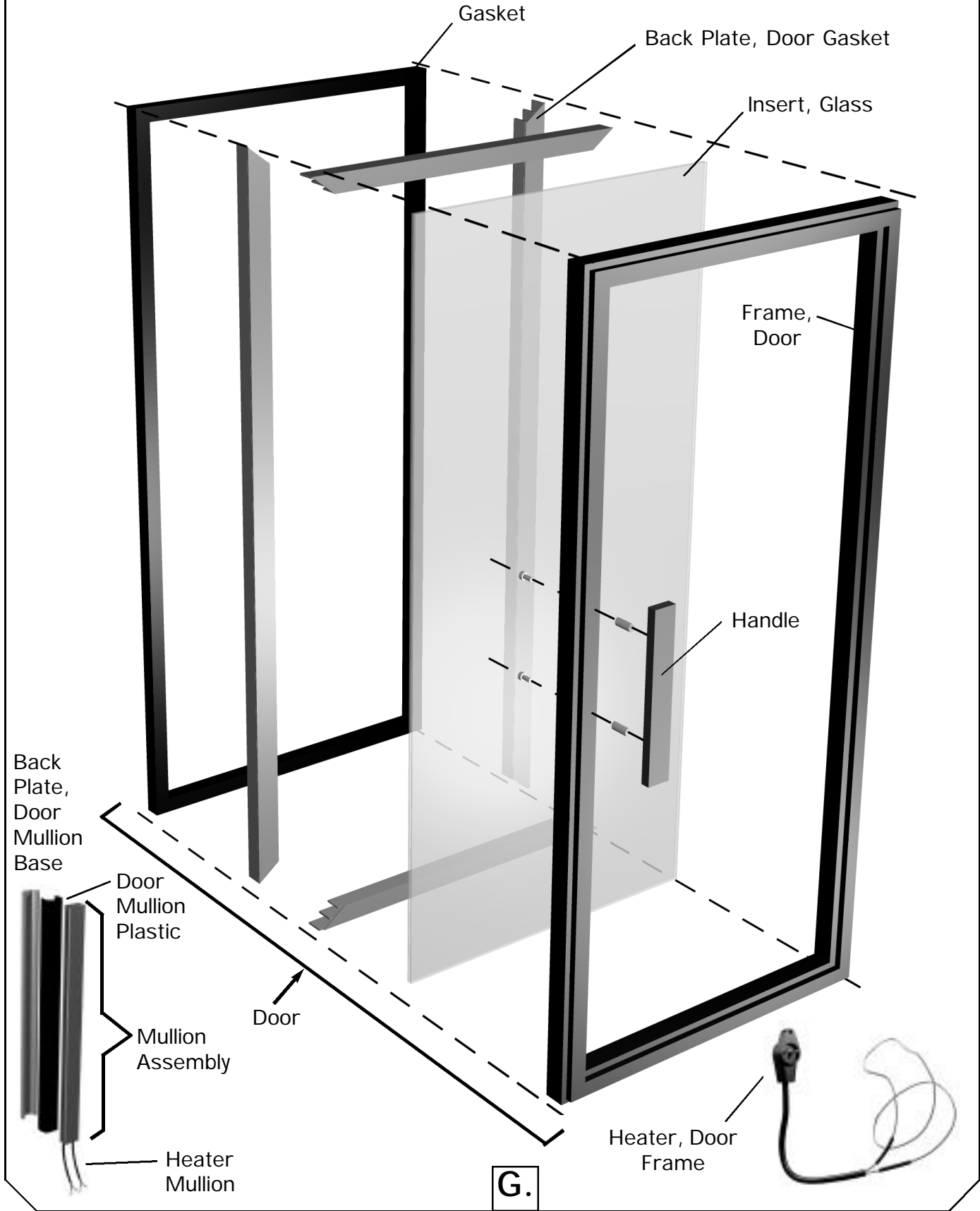

Door Parts

GDM Freezer Door Hinges

GDM-7F Kit, Door Hinge Top

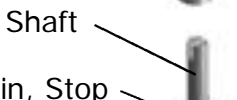
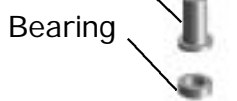
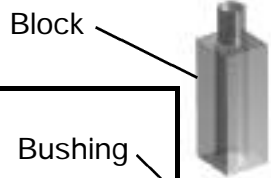
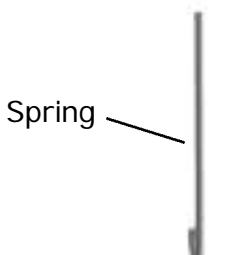
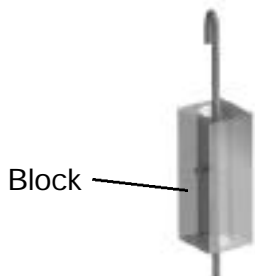
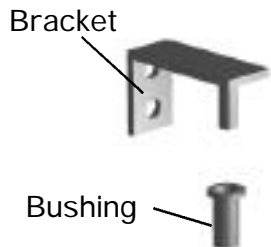

Kit, Door Hinge Bottom

GDM-6F, GDM-10F Kit, Door Hinge Top

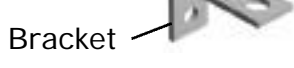
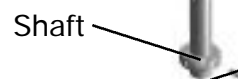
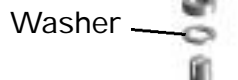
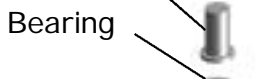
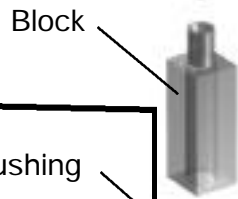
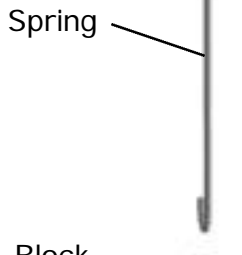
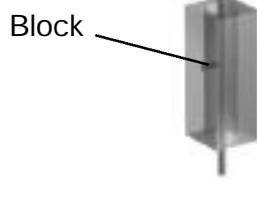
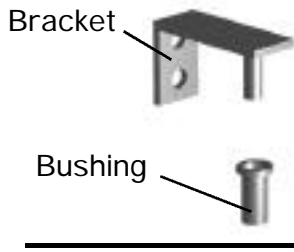

Kit, Door Hinge Bottom

Before Serial NO. 1-1775723

GDM-12F Kit, Door Hinge Top

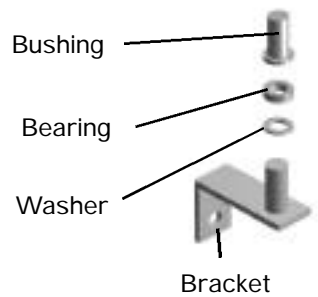
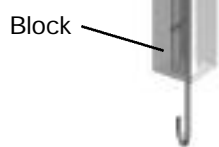
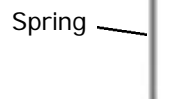
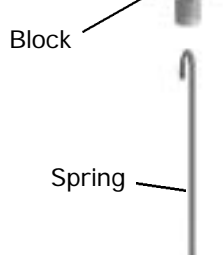
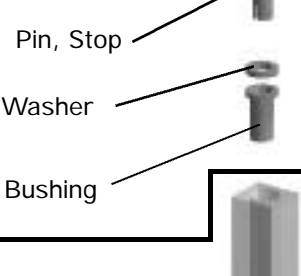
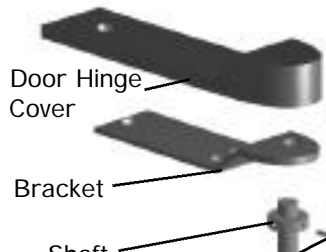

Kit, Door Hinge Bottom

All Others Kit, Door Hinge Top

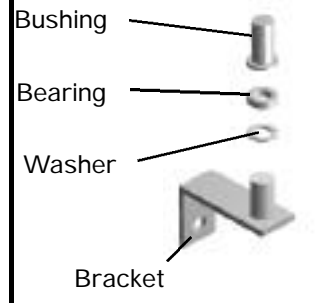
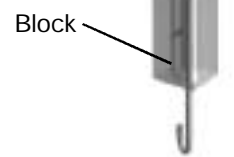
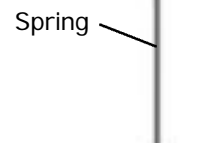
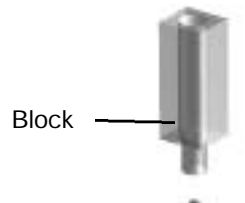
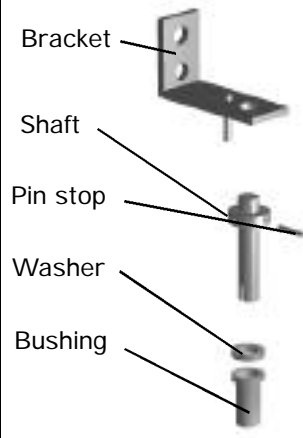

Kit, Door Hinge Bottom

H.

Door Parts

GDM Freezer Models

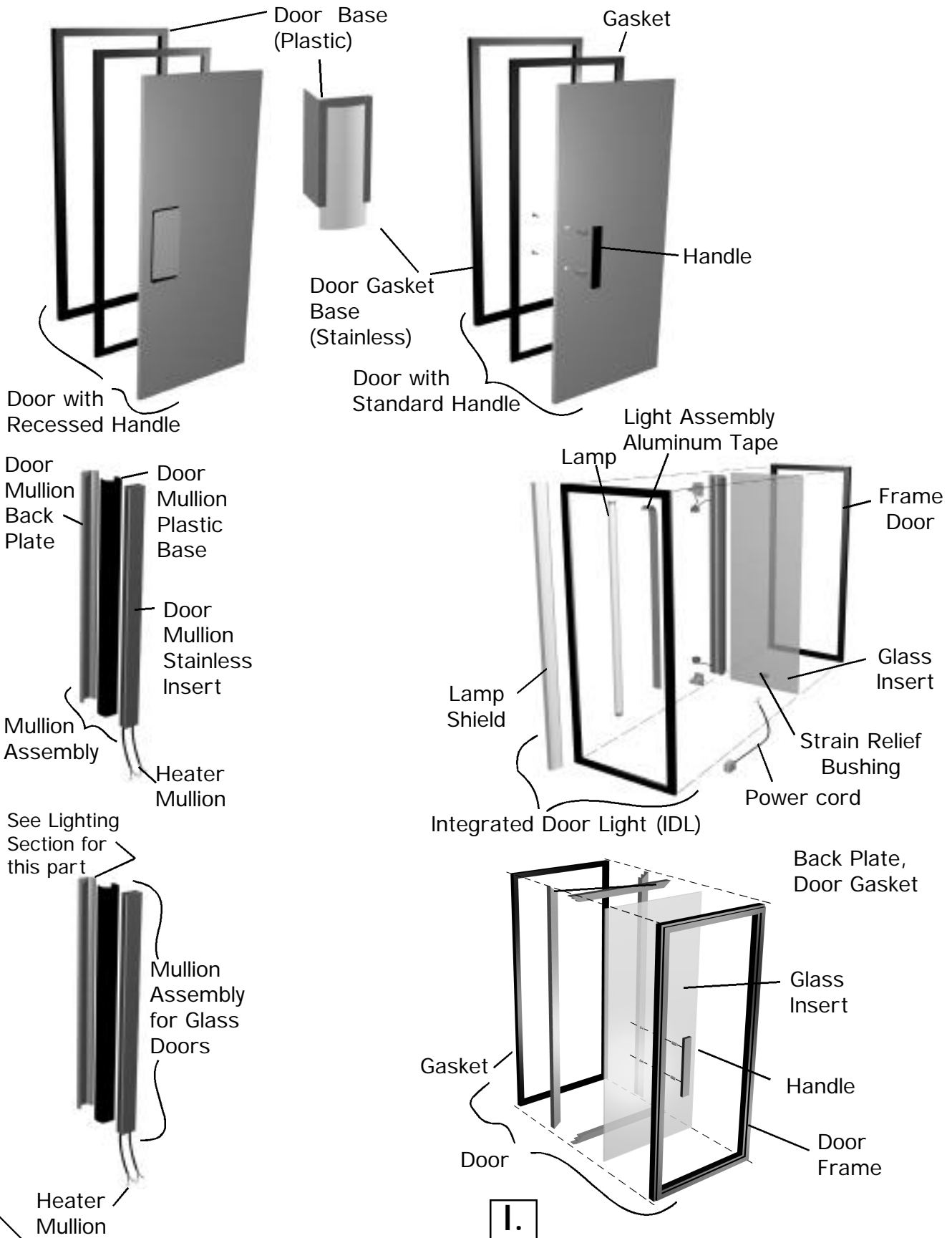

Evaporator Parts

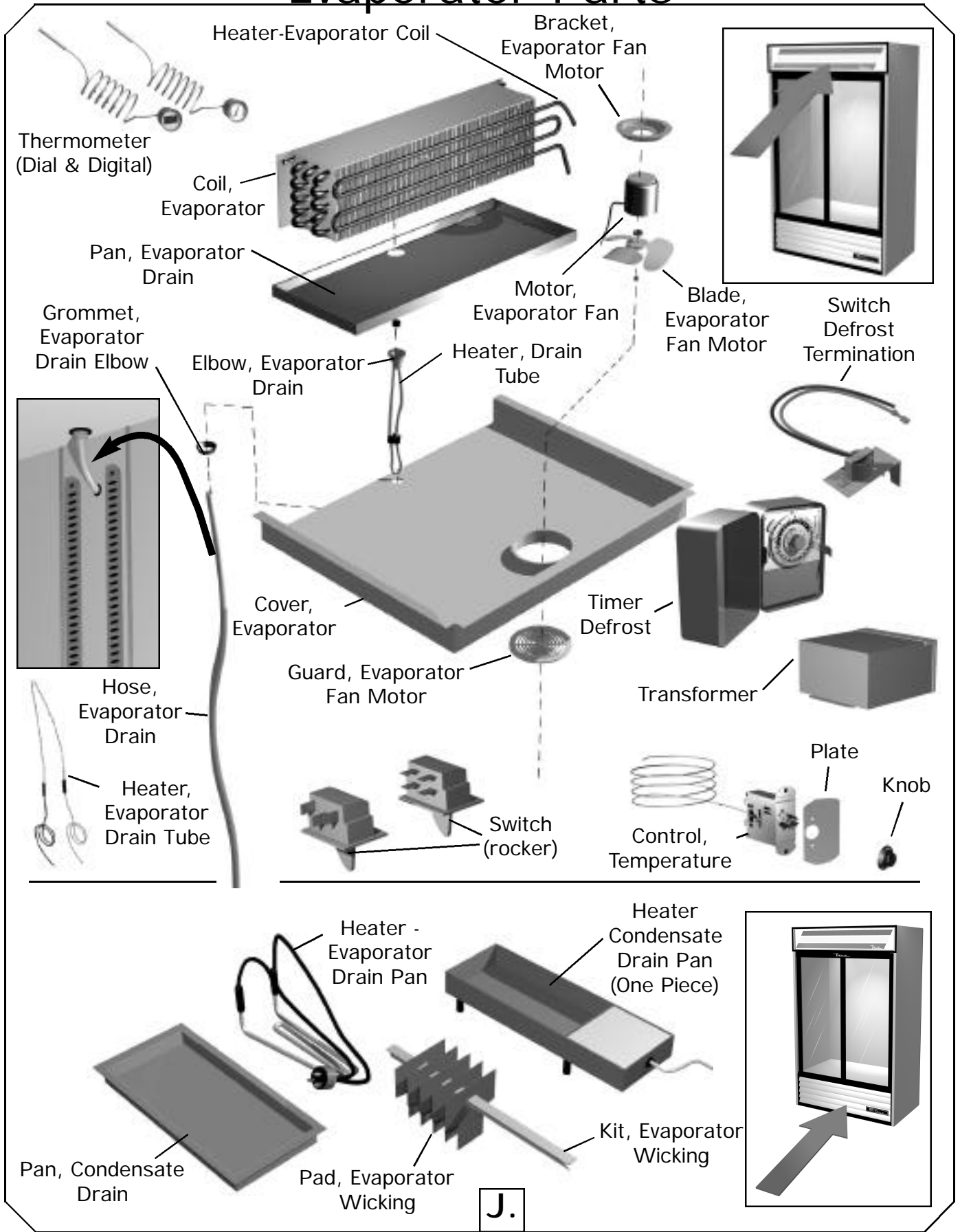

J.

Grill Parts

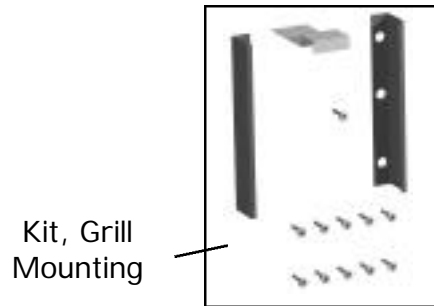
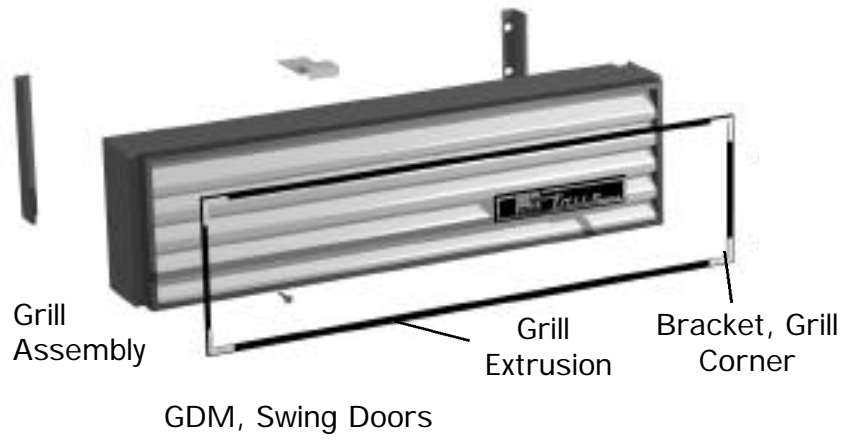

Grill Assembly (GDIM)

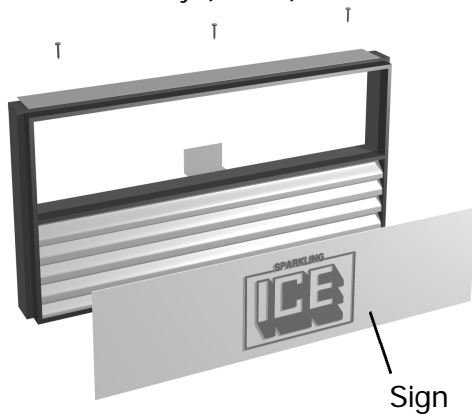

Grill - Lower (GDM - 12F)

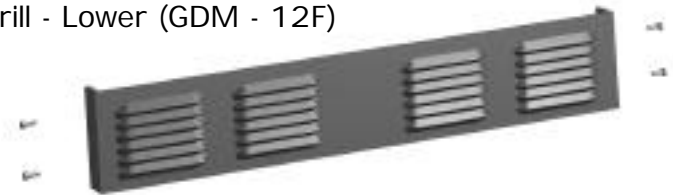

Lighting Parts

GDM Freezer Models

Light Assembly

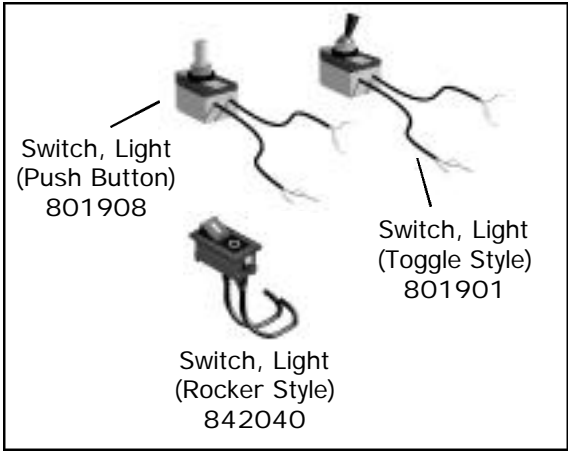
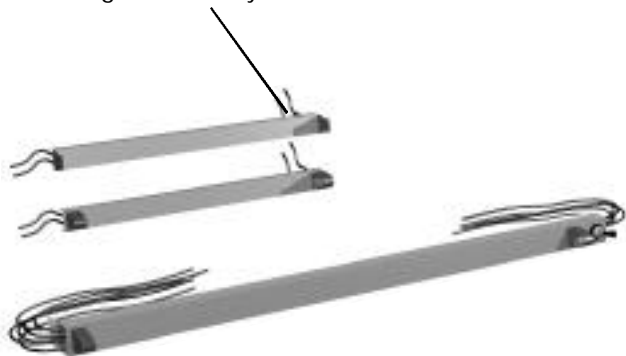

Switch, Light
(Push Button)
801908

Switch, Light
(Toggle Style)
801901

Switch, Light
(Rocker Style)
842040

Lamp

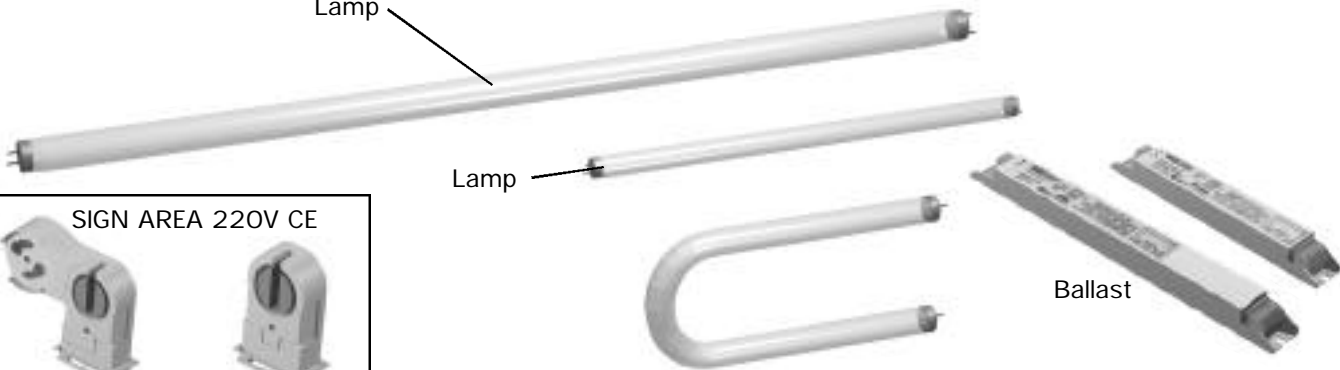

Lamp

Ballast

SIGN AREA 220V CE



225-C-13
842063

225-S/13
842062

Interior Lampholders
Non-IDL Top or Bottom
501.5 Kulka
801250



DOOR LAMPHOLDERS



For VHO Lamps
Top of IDL Door
#540 (w/53" Lead)
801359



For 24K Lamps
Top of IDL Door
#542 (52 3/4" Lead)
801230



Bottom of IDL Door
#540 (5 3/4" Lead)
801358



Bottom of IDL Door
#542 (4 1/2" Lead)
801254

SIGN AREA IDL AND NON-IDL
& CENTER MULLION FOR 24K
LAMPS



Springloaded
13570
801223

Stationary
13571
801224



842056

842054

842111

LR-110
801222

Lampholders



Starter



Base, Light
Starter



Lampholder Sleeve



Base, Light
Starter 800510



Ballast, Sign
LC-14-20C

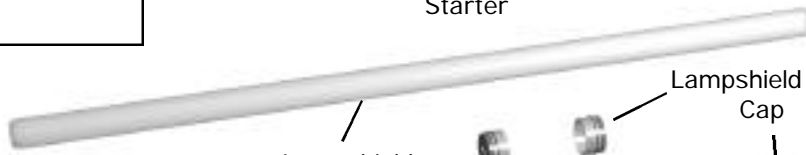

Lampshield

Lampshield End
Cap

L.

Shelf Parts

GDM Freezer Models

Backguard Shelf Standard Bracket Shelf Standard

Baffle, Air Back

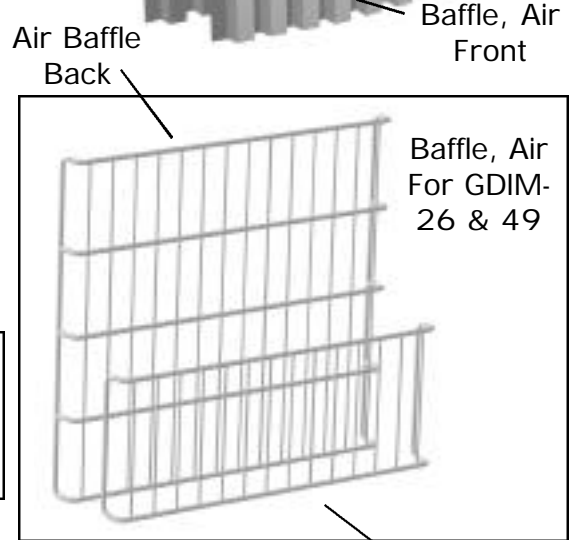
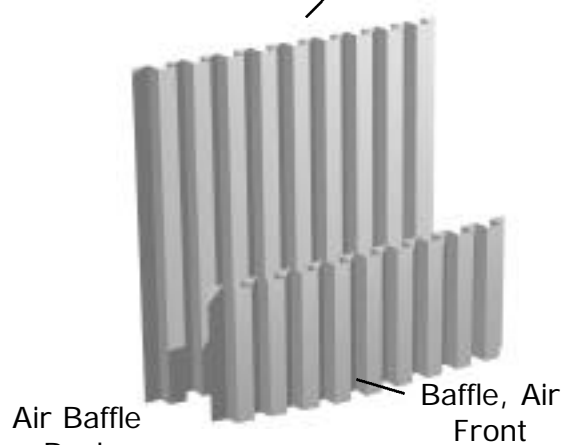
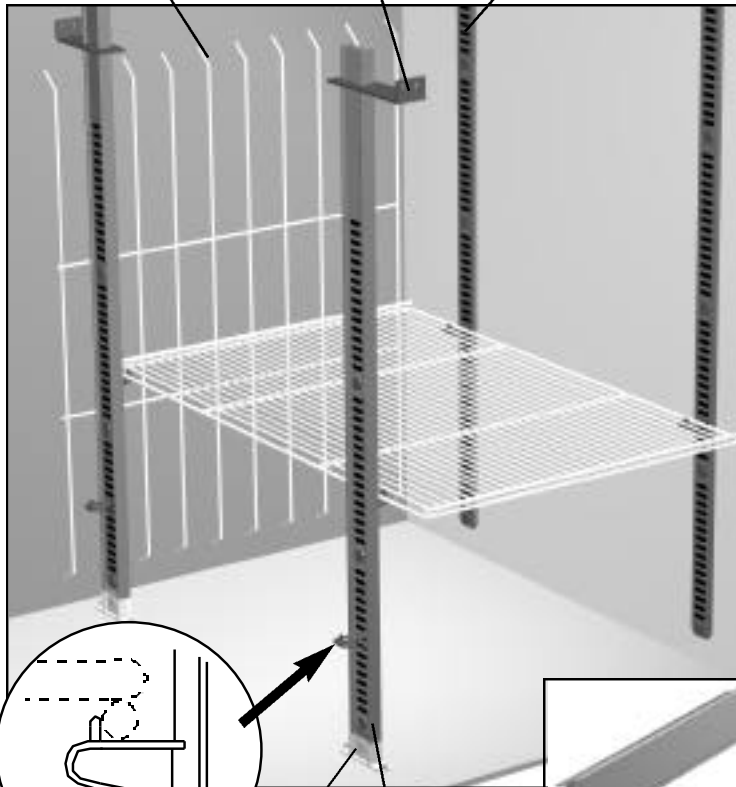

Baffle, Air For GDIM-26 & 49



Wire Shelf Pricing Strip

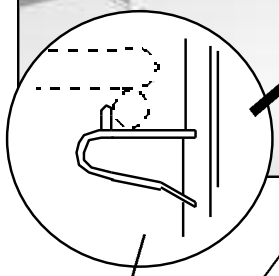

Clip, Shelf

Bracket, Shelf Standard Shelf Standard (Center)

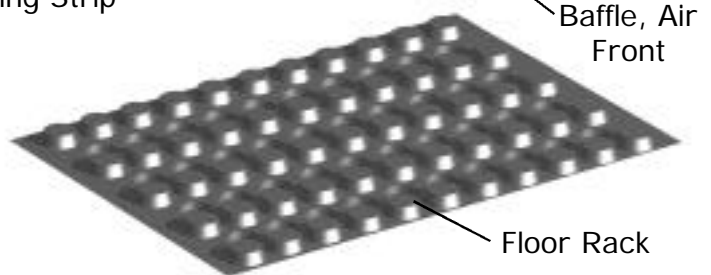

Baffle, Air Front

Floor Rack

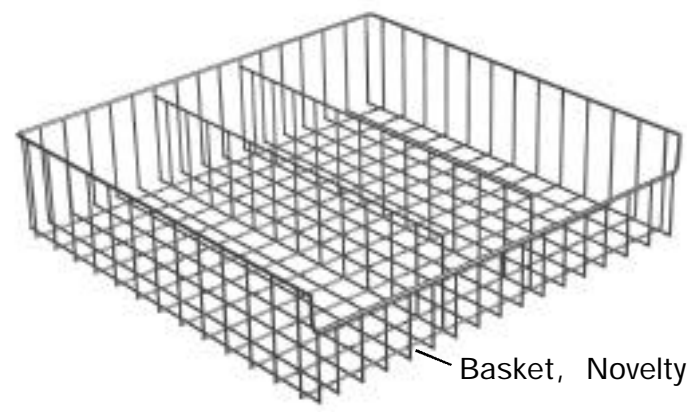

Basket, Novelty

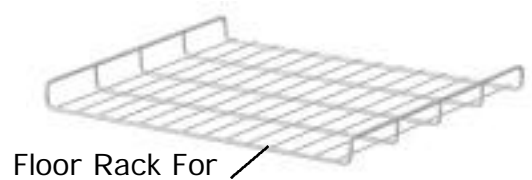

Floor Rack For GDIM-60 & 26

M.

Sign & Sign Frame Parts

